

• General Description

The ZMS070N10P combines advanced trench MOSFET technology with a low resistance package to provide extremely low $R_{DS(ON)}$.

• Features

- Advance device constructure
- Low $R_{DS(ON)}$ to minimize conduction loss
- Low Gate Charge for fast switching
- Low Thermal resistance

• Application

- Synchronous Rectification for AC-DC/DC-DC converter
- Power Tools

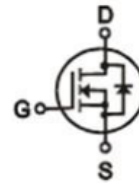
• Product Summary

$V_{DS} = 100V$

$R_{DS(ON)} = 7m\Omega$

$I_D = 100A$

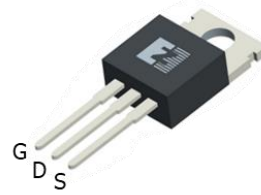

TO-220

• Ordering Information:

Part NO.	ZMS070N10P
Marking	ZMS070N10
Packing Information	Bulk Tube
Basic ordering unit (pcs)	1000

• Absolute Maximum Ratings ($T_c = 25^\circ C$)

Parameter	Symbol	Rating	Unit
Drain-Source Voltage	V_{DS}	100	V
Gate-Source Voltage	V_{GS}	± 20	V
Continuous Drain Current	$I_D @ TC=25^\circ C$	100	A
	$I_D @ TC=75^\circ C$	76	A
	$I_D @ TC=100^\circ C$	63	A
Pulsed Drain Current ^①	I_{DM}	300	A
Total Power Dissipation($TC=25^\circ C$)	$P_D @ TC=25^\circ C$	150	W
Operating Junction Temperature	T_J	-55 to 150	$^\circ C$
Storage Temperature	T_{STG}	-55 to 150	$^\circ C$
Single Pulse Avalanche Energy@L=0.1mH	E_{AS}	50	mJ
Avalanche Current@L=0.1mH	I_{AS}	35	A

•Thermal resistance

Parameter	Symbol	Min.	Typ.	Max.	Unit
Thermal resistance, junction - case	R _{thJC}	-	-	0.75	° C/W
Thermal resistance, junction - ambient	R _{thJA}	-	-	50	° C/W
Soldering temperature, wavesoldering for 10s	T _{sold}	-	-	265	° C

•Electronic Characteristics

Parameter	Symbol	Condition	Min.	Typ	Max.	Unit
Drain-Source Breakdown Voltage	BV _{DSS}	V _{GS} =0V, I _D =250uA	100			V
Gate Threshold Voltage	V _{GS(TH)}	V _{GS} =V _{DS} , I _D =250uA	1.3	1.7	2.5	V
Drain-Source Leakage Current	I _{DSS}	V _{DS} =100V, V _{GS} =0V			1.0	uA
Gate- Source Leakage Current	I _{GSS}	V _{GS} =±20V, V _{DS} =0V			±100	nA
Static Drain-source On Resistance	R _{DS(ON)}	V _{GS} =10V, I _D =30A		7	9	mΩ
		V _{GS} =4.5V, I _D =20A		9	11	mΩ
Forward Transconductance	g _{FS}	V _{DS} =10V, I _D =40A		18		s
Diode Forward Voltage	V _{FSD}	I _S =30A			1.2	V

•Electronic Characteristics

Parameter	Symbol	Condition	Min.	Typ	Max.	Unit
Input capacitance	C _{iss}	V _{GS} =0V, V _{DS} =25V f = 1MHz	-	2120	-	pF
Output capacitance	C _{oss}		-	940	-	
Reverse transfer capacitance	C _{rss}		-	48	-	

•Switching Parameters (T_a = 25°C)

Parameter	Symbol	Condition	Min.	Typ	Max.	Unit
Total gate charge	Q _g	V _{DD} =30V I _D = 10A V _{GS} = 10V	-	28	-	nC
Gate - Source charge	Q _{gs}		-	3.8	-	
Gate - Drain charge	Q _{gd}		-	5.9	-	
Turn-ON Delay time	t _{D(on)}	V _{GS} =10V, V _{DS} =50V, R =0.75Ω, R =6Ω		15		nS
Turn-ON Rise time	t _r			17		
Turn-Off Delay time	t _{D(off)}			96		

Turn-Off Fall time	t_f		76		
Body Diode Reverse Recovery Time	t_{rr}	IF=20A, dI/dt=100A/μs	47		nS
Body Diode Reverse Recovery Charge	Q_{rr}	IF=20A, dI/dt=100A/μs	38		nC

Note: ① Pulse Test : Pulse width ≤ 10μs, Duty cycle ≤ 1% ;

Fig.1 Gate-Charge Characteristics

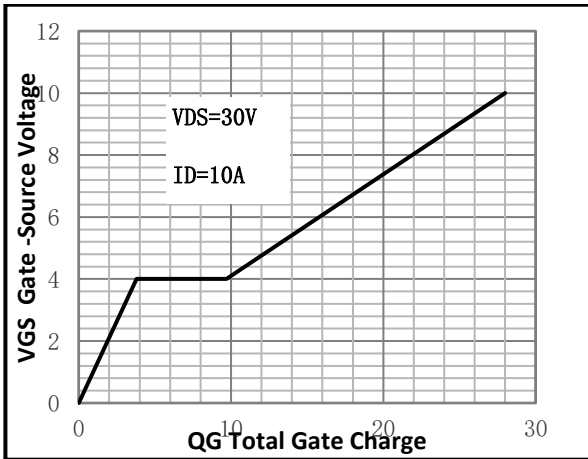

Fig.2 Capacitance Characteristics

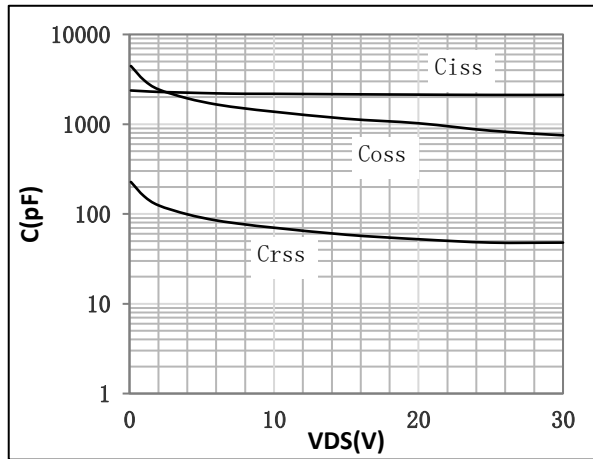

Fig.3 Power Dissipation

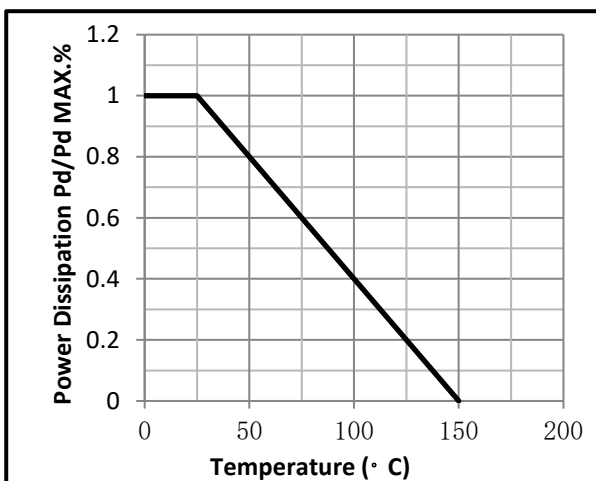

Fig.4 Typical output Characteristics

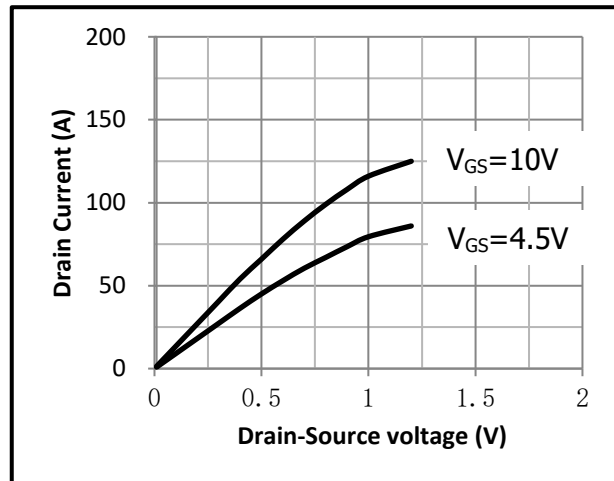

Fig.5 Threshold Voltage V.S Junction Temperature

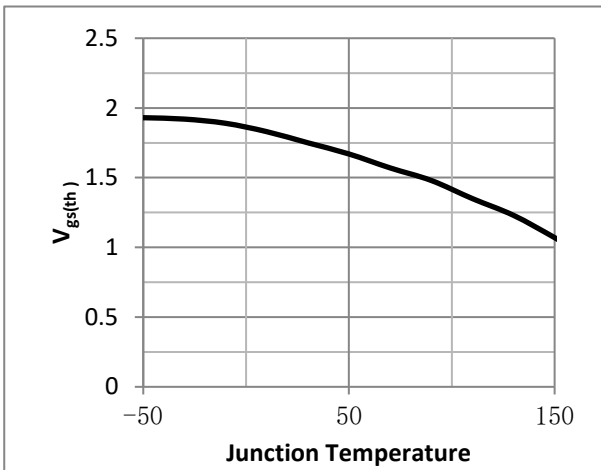

Fig.6 Resistance V.S Drain Current

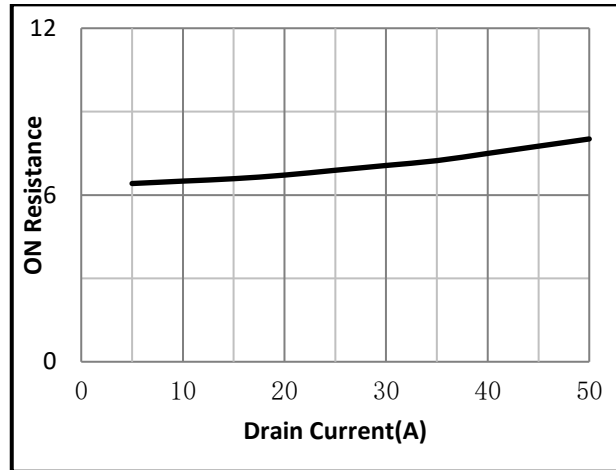

Fig.7 On-Resistance VS Gate Source Voltage

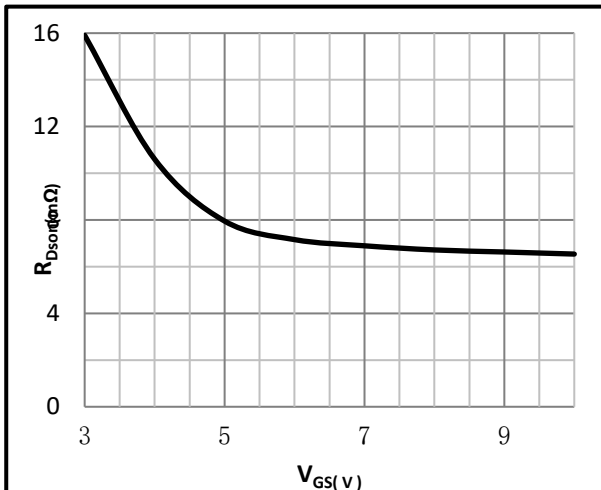

Fig.8 On-Resistance V.S Junction Temperature

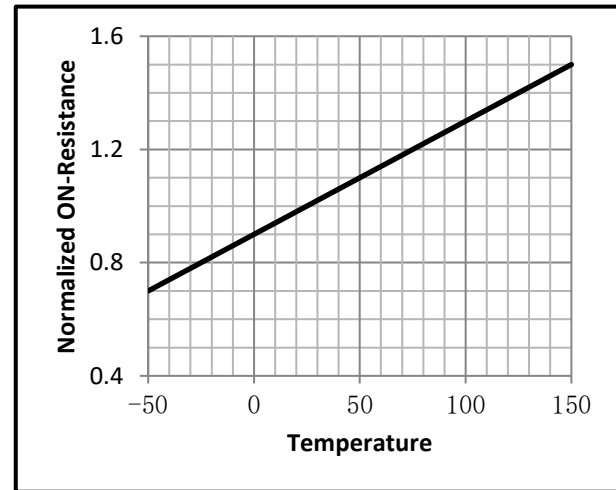

Fig.9 Gate Charge Measurement Circuit

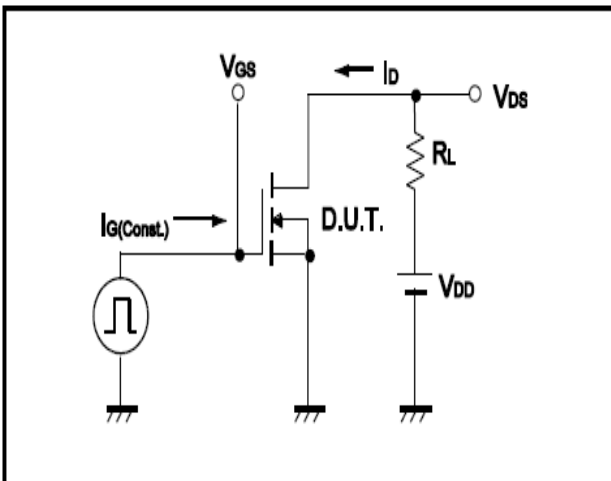

Fig.10 Gate Charge Waveform

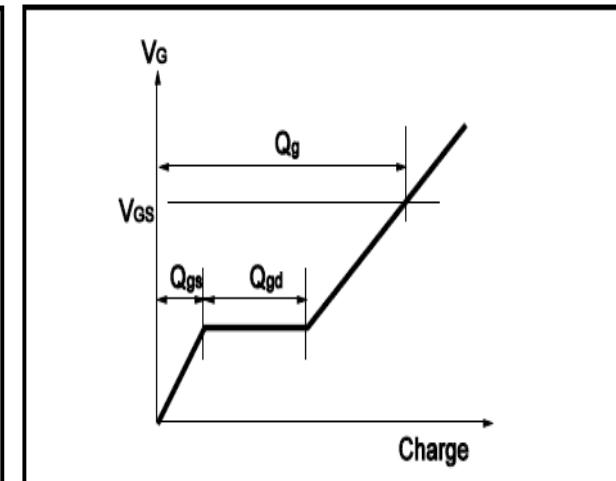

Fig.11 Switching Time Measurement Circuit

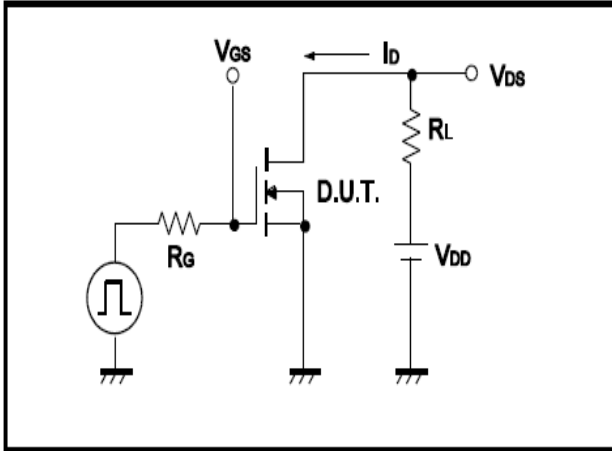
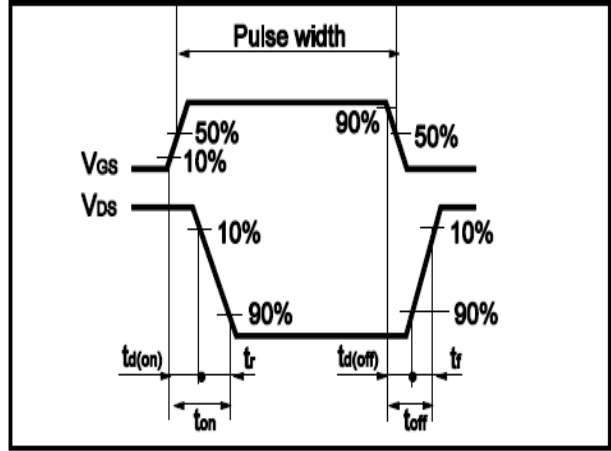

Fig.12 Switching Time Waveform



• Dimensions (TO-220)

Unit: mm

SYMBOL	min	nom	max	SYMBOL	min	nom	max
A	4.00		4.80	E	9.90		10.70
B	1.20		1.50	e		2.54	
B1	1.00		1.40	F	1.10		1.45
b1	0.65		1.00	L	12.50		14.50
c	0.35		0.75	L1	3.00	3.50	4.00
D	15.00		16.50	Q	2.50		3.00
D1	5.90		6.90	Q1	2.00		3.00
				ΦP	3.60		3.90

